

VECTOR 800LM/M, 830, GREY

ITAB

✓ Available in different lengths and lumen outputs

TECHNICAL SPECIFICATION

Product Code	231-107-001
Colour	Grey
Control	On/off
CRI light colour	830
Delivered lumen output lm	650lm/m
Driver	Separate
EEL	A
Light distribution	Flood
Lightsource	LED Linear
Mains input voltage	220-240 V
Measurements A	20
Measurements B	14,5
Mounting	Surface
Position	Fixed
Lifetime	L80 B10, 50.000h
Protection	IP 20, class III
Start Time	Instant
System power W	7W/m
Unit	mm
Weight	0,41kg/m

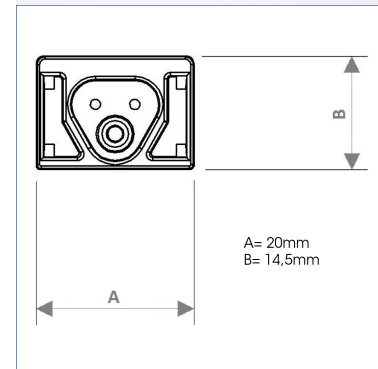

Flood	
m	°
1.0	2.89
2.0	5.78
3.0	8.67